

6GM8 & E88CC: 1/A2; 2/G2; 3/K2 4,5/H; 6/A1; 7/G1; 8/K1; 9/S

6AS7G: 1/G2; 2/A2, 3/K2, 4/G1; 5/A1; 6/K1; 7,8/H

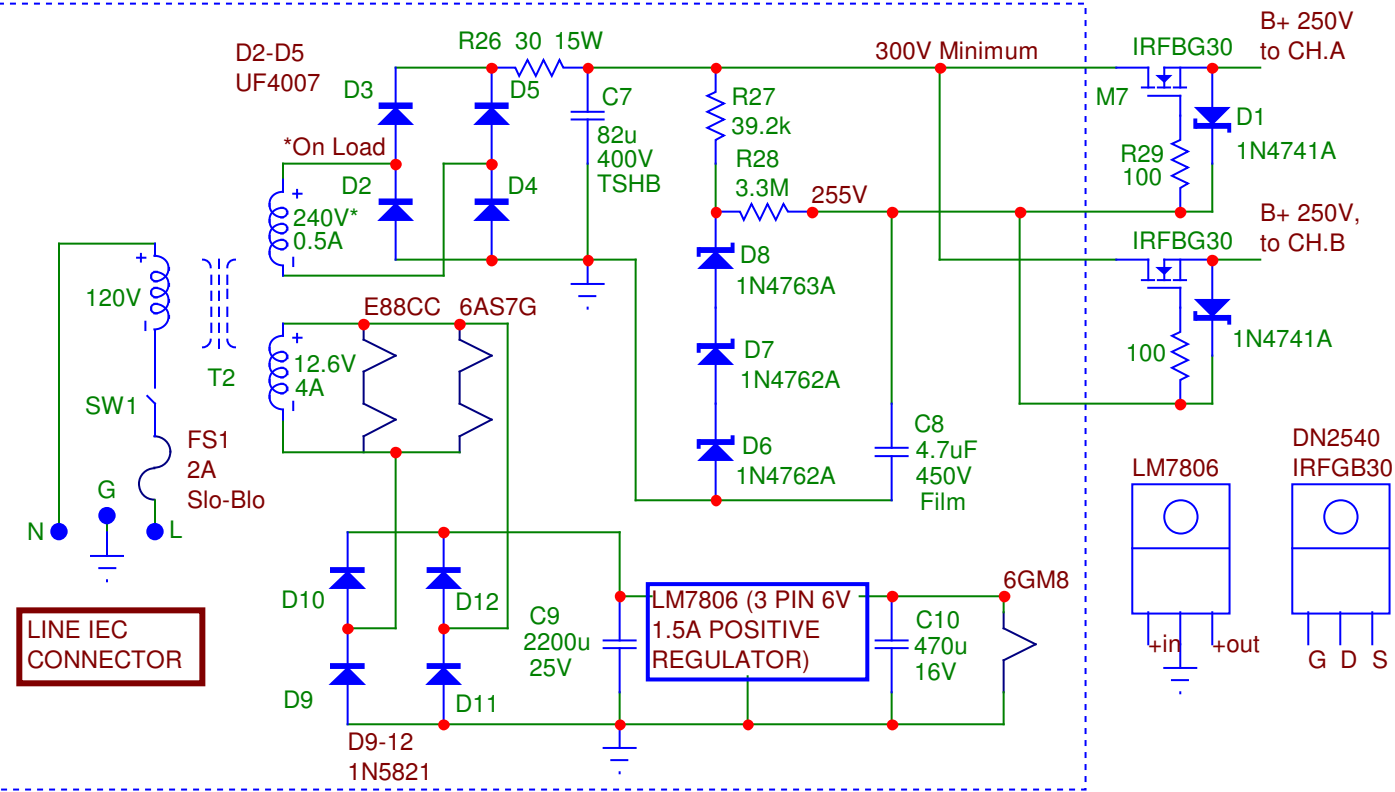
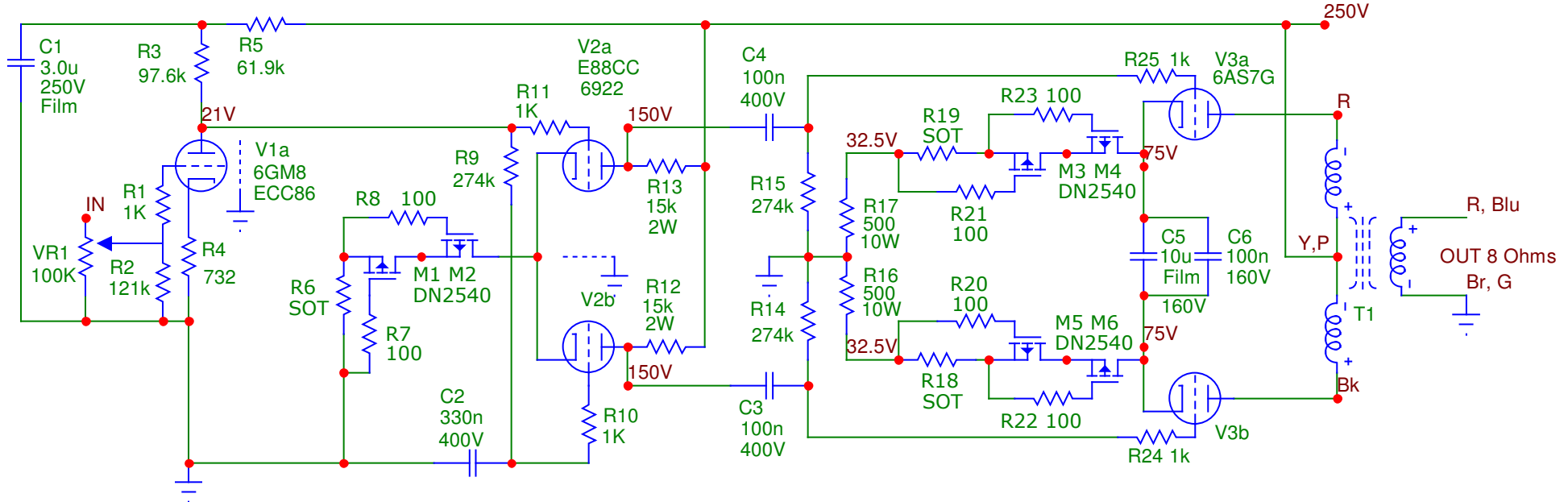

Notes:
 T1 Talema 62081
 (Approximately 4.1k:8R)
 T2 Maryland Toroid Custom #8383
 Capacitor voltage ratings are recommended minimum values.

Components inside dashed box are common to a stereo amplifier.

This document & the information herein is the sole property of Richard F. Sears and shall not be used for commercial purposes without the express written permission of Richard F. Sears. (richard@triodeguy.com)